

FAMILY
SRAM X01

X01



SRAM®
ONE. AND ONLY.

FORMAT
PRESS RELEASE



ONE. AND ONLY.

SRAM 1X™ is the only one you need: less weight, better chain control and the ability to sync up with any riding style. Our 1X drivetrain philosophy focuses on optimizing how components work together—crank to ring, tooth to chain, shifter to derailleur, derailleur to cassette, and cassette to wheel. No matter where you ride, no matter what you're up against, SRAM 1X takes you further.



Building the next generation of single chain ring drivetrains takes more than a few well-made components—it takes components made perfectly for each other. The result: flawless chain management, lower weight and faster, more precise shifting.



X-HORIZON

This rear derailleur's "straight parallelogram" design limits all movement to the horizontal axis, which makes ghost shifting impossible while also reducing shift force. For quicker, more exact shifting, the large upper pulley offset design maintains a constant chain gap across all gears.

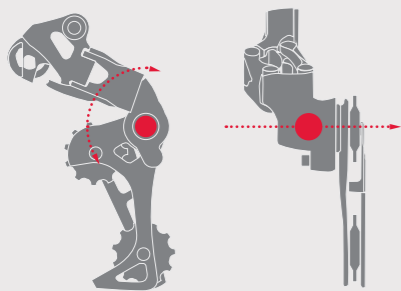

HARD CHROME™

The XX1 Chain has 4 times the elongation (wear) resistance to our other chains. This is due to the new finishing process on the inner links and rollers. Push pin strength and ultimate strength are equivalent to our current chains. The XX1 Chain lasts longer and is just as strong.

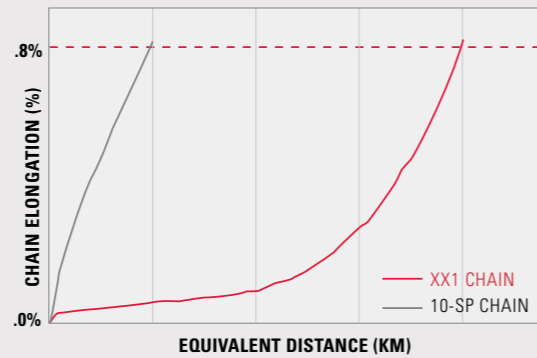

XD™ DRIVER BODY

XD is a cassette driver body design that allows the use of a 10-tooth small cog and provides an improved interface with the cassette.



X-ACTUATION™

Developed specifically for SRAM 1X, X-ACTUATION keeps shifting sharp and consistent across the entire 10- to 42-tooth cassette.



X-DOME

X-DOME technology creates an incredibly lightweight, precise and strong cassette. The open design aids in mud clearance, giving you cleaner shifting performance and longer component life.



GXP

GXP's Gutter Seal design cuts friction, durability and weight—improving both feel and performance.



X-SYNC

A CNC-machined, "wide tooth, narrow tooth" pattern is repeated around the entire chain ring, perfectly mirroring the chain's inner and outer links for maximum control.

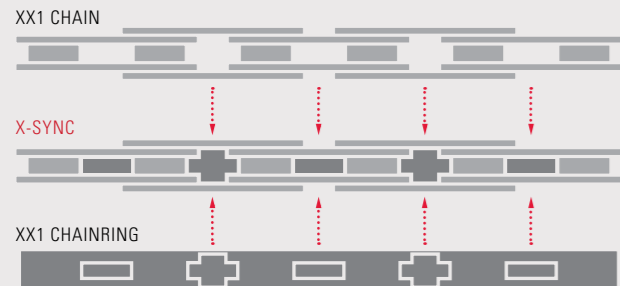

CAGE LOCK™

With CAGE LOCK technology in the rear derailleur, wheel removal and installation—as well as chain installation—becomes faster and simpler. Just pushing the cage forward to create slack and lock it into place.



SPEED METAL™

Full metal, 11-speed indexing keeps shifting crisp and precise with Grip Shift.

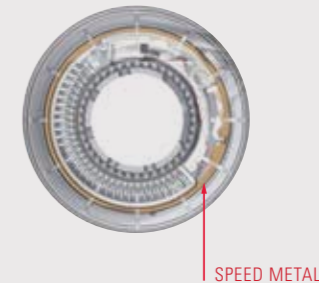

ROLLING THUNDER™

Three rows of ball bearings provide zero friction or play—reducing the force needed to shift and promoting long-term performance under all weather conditions with Grip Shift.

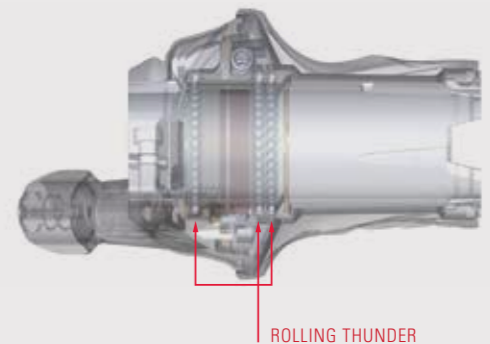

ROLLER BEARING CLUTCH™

ROLLER BEARING CLUTCH technology eliminates derailleur bounce and chain slap without sacrificing precision.



BB30

Besides serious weight savings, this bottom bracket means narrow Q-factor, more ankle clearance, greater bearing durability and stronger crank construction.



JAWS™

Once the Grip Shift shifter and grip interlock securely, forged aluminum clamps on either end reinforce the assembly by locking tightly to the handlebar.

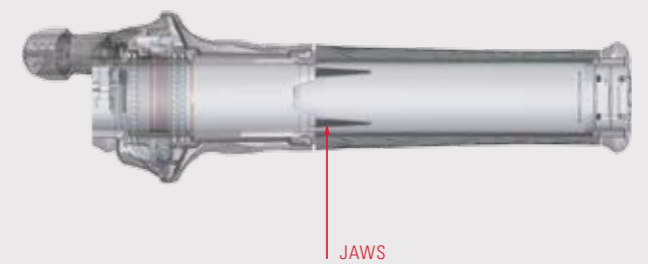

X01

DESCRIPTION
ALL FOR ONE

The SRAM X01 drivetrain carries on the tradition of SRAM's championship-winning 1X™ philosophy—all the way down the mountain. The setup is simpler. The drivetrain is lighter. And the shifting is fast but solid. Bottom line: X01 is the right one for any terrain, every time. **RELENTLESS.**



1. NEW X01 CRANKSET

- New patented X-SYNC™ tooth profile provides maximum chain control
- Carbon arms with forged aluminum spider
- Chainring guard option
- New spider design allows for easier ring changes
- CNC- X-SYNC machined rings (30-32-34-36-38)
- Colors: Red and Black
- Weight: 655g (with BB)
- Technologies: BB30, GXP, X-SYNC
- Also available: SRAM X1 Crankset

2. NEW X01 X-HORIZON™ REAR DERAILLEUR

- Large upper pulley offset automatically adjusts chain gap
- X-HORIZON™ design reduces shift force and ghost shifting
- 12-tooth X-SYNC™ pulley wheels
- TYPE 2 technologies: ROLLING BEARING CLUTCH™ and CAGE LOCK™
- Carbon cage
- Sealed cartridge bearings
- Colors: Red and Black
- Weight: 252g
- Technologies: X-ACTUATION™, X-HORIZON, X-SYNC, ROLLER BEARING CLUTCH, CAGE LOCK

3. NEW X01 TRIGGER SHIFTER

- SRAM 1X X-ACTUATION for precise and dependable 11-speed performance
- ZERO LOSS engagement for fastest shifting
- Multi-adjustable trigger shifter
- MatchMaker X compatible
- Aluminum cover and adjustable forged aluminum pull lever
- Includes discrete clamp
- Colors: Red and Black
- Weight: 91g
- Technologies: X-ACTUATION, ZERO LOSS, MatchMaker X Integrated

4. NEW X01 GRIP SHIFT

- SRAM 1X X-ACTUATION for precise and dependable 11-speed performance
- SPEED METAL™ shift indexing
- ROLLING THUNDER™ ball bearing technology
- JAWS™ lock-on grip technology
- Aluminum cover
- Includes lock-on grips
- Colors: Red and Black
- Weight: 143g (clamps, cable, and lock-on grip)
- Technologies: JAWS, ROLLING THUNDER, SPEED METAL, X-ACTUATION

5. NEW XG-1195 CASSETTE

- Unique finish for high durability
- 11-speeds (10-12-14-16-18-21-24-28-32-36-42)
- XD™ Driver Body creates more stable hub connection
- Optimized gear steps across entire range
- Weight: 275g
- Technologies: X-DOME™, XD DRIVER BODY

6. XD DRIVER BODY

- Driver body design that lets riders tap the power and range of the SRAM 10-42 11-speed Cassette and a 10-tooth small cog
- Provides a more stable hub connection
- XD Driver Body is 6-8g lighter

7. PC-XX1 CHAIN

- New 1X specific chain
- HARD CHROME™ technology for maximum strength and wear resistance
- Proprietary link finish provides improved life span
- 11-speed power lock
- Weight: 252g (114 links)
- Technologies: X-SYNC, HARD CHROME

X01 AVAILABILITY: MID-SEPTEMBER 2013

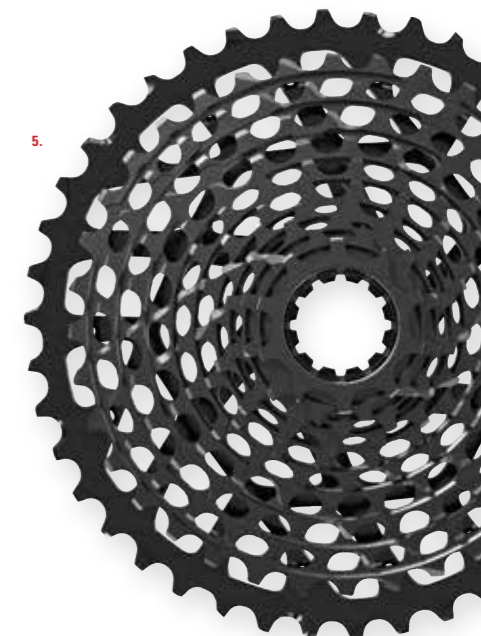

EXTERNAL DRIVETRAIN PRODUCT OFFERINGS

■ NEW ■ UPDATED ■ NO CHANGE

	CROSS COUNTRY	TRAIL	ALL MOUNTAIN	FREERIDE	DOWNHILL
SSSSS		XX			
			XX1		
SSSS			X0		
			X01		
SSS			X9		
			X7		
SS			X5		
			X4		
S			X3		

X01 PRODUCT LINE

X01

SPECS	X01 CRANKSET	X01 X-HORIZON™ RD	X01 TRIGGER SHIFTER	X01 GRIP SHIFT	XG-1195 CASSETTE	PC-XX1 CHAIN
VARIANTS	BB30 and GXP: 30, 32, 34, 36, 38	Horizontal Parallelogram design	1X11	1X11	10-42	11-speed
WEIGHTS	655g	252g	91g	143g (clamps, cable, JAWS lock-on grip), 103g (clamps, cable) and 40g (lock-on grip)	275g	252g
TECHNOLOGIES	BB30, GXP and X-SYNC	X-ACTUATION, X-HORIZON, X-SYNC, ROLLER BEARING CLUTCH, and CAGE LOCK	X-ACTUATION, ZERO LOSS and Matchmaker X Integrated	JAWS, ROLLING THUNDER, SPEED METAL, and X-ACTUATION	X-DOME and XD DRIVER BODY	X-SYNC and HARD CHROME
SPEEDS	1X	1X11	11-speed	11-speed	11-speed	11-speed
COMPATIBILITY	1X11 X-SYNC	10-42 cassette	1X11 X-ACTUATION	1X11 X-ACTUATION	PC-XX1 Chain and XD Driver Body	10-42 cassette, 1X11 X-SYNC and 1X11 X-ACTUATION
MATERIALS	Carbon composite/ aluminum spider, AL-7075-T651 rings	Carbon fiber or aluminum outer cage	Aluminum cover, adjustable forged aluminum pull lever	Aluminum cover	4130 chromoly steel (cog cluster), AL-7075-T6 (largest cog)	n/a
HARDWARE	AL-7075-T6; TORX T25 and 6mm hex bolts	Stainless steel	Aluminum, stainless	n/a	n/a	n/a
KEY FEATURES	Carbon guard available	Cartridge bearings	X-ACTUATION, MMX Compatible	ROLLING THUNDER, SPEED METAL, JAWS	XD Driver Body attachment to hub	11-speed power lock
OPTIONS	170 and 175mm arm lengths; Red and Black	Red and Black	MatchMaker X; Red and Black	Red and Black	n/a	n/a

*SRAM X1 Crankset is only offered as an original equipment manufactured component.

X01 MSRP

X01

COMPONENT	MSRP USA	MSRP EUROPE
XG-1195 CASSETTE 10-42 11-SPEED, FITS XD DRIVER BODY	\$399	€ 359
PC XX1 CHAIN 118 LINKS, INCLUDES POWERLOCK	\$63	€ 57
SRAM X01 CRANKSET X01 - GXP INCLUDES CHAIN RING BOLTS (CHAIN RING AND GXP CUPS NOT INCLUDED)	\$279	€ 251
SRAM X01 CRANKSET X01 - BB30 INCLUDES CHAIN RING BOLTS (CHAIN RING AND BB30 BEARINGS NOT INCLUDED)	\$319	€ 287
X01 TRIGGER SHIFTER INCLUDES DISCRETE CLAMP	\$139	€ 125
X01 GRIP SHIFT INCLUDES JAWS LOCK-ON GRIPS	\$129	€ 116
X01 X-HORIZON REAR DERAILLEUR 11-SPEED	\$269	€ 242
X01 X-SYNC CHAIN RING - 30T	\$98	€ 88
X01 X-SYNC CHAIN RING - 32T	\$105	€ 95
X01 X-SYNC CHAIN RING - 34T	\$113	€ 102
X01 X-SYNC CHAIN RING - 36T	\$120	€ 108
X01 X-SYNC CHAIN RING - 38T	\$127	€ 114



The SRAM logo is displayed in a bold, italicized, white sans-serif font. The letters are closely spaced, and a registered trademark symbol (®) is located at the top right of the letter 'M'. The background of the entire page is a photograph of a forest with a strong red color cast, creating a dramatic and intense atmosphere.

RELENTLESS

To be the best. It's why you ride. It's why we build components. The perfect combination of precision and brute force. No obstacles stopping us. No limitations slowing us down. Ours is a relentless pursuit: to make the climb shorter, the trail smoother, the turn tighter, the descent faster. To give you the strongest, lightest, quickest bike on earth. To be the best.

NORTH AMERICA

Tyler Morland
312 576 8267
tmorland@sram.com

EUROPE

Simon Cittati
+49 173 695 6103
scittati@sram.com

PHOTO: SVEN MARTIN (COVER) ADRIAN MARCOUX (1 and 5)

© 2013 SRAM LLC
SRAM.COM